

Toroidal transformer type L8670PT

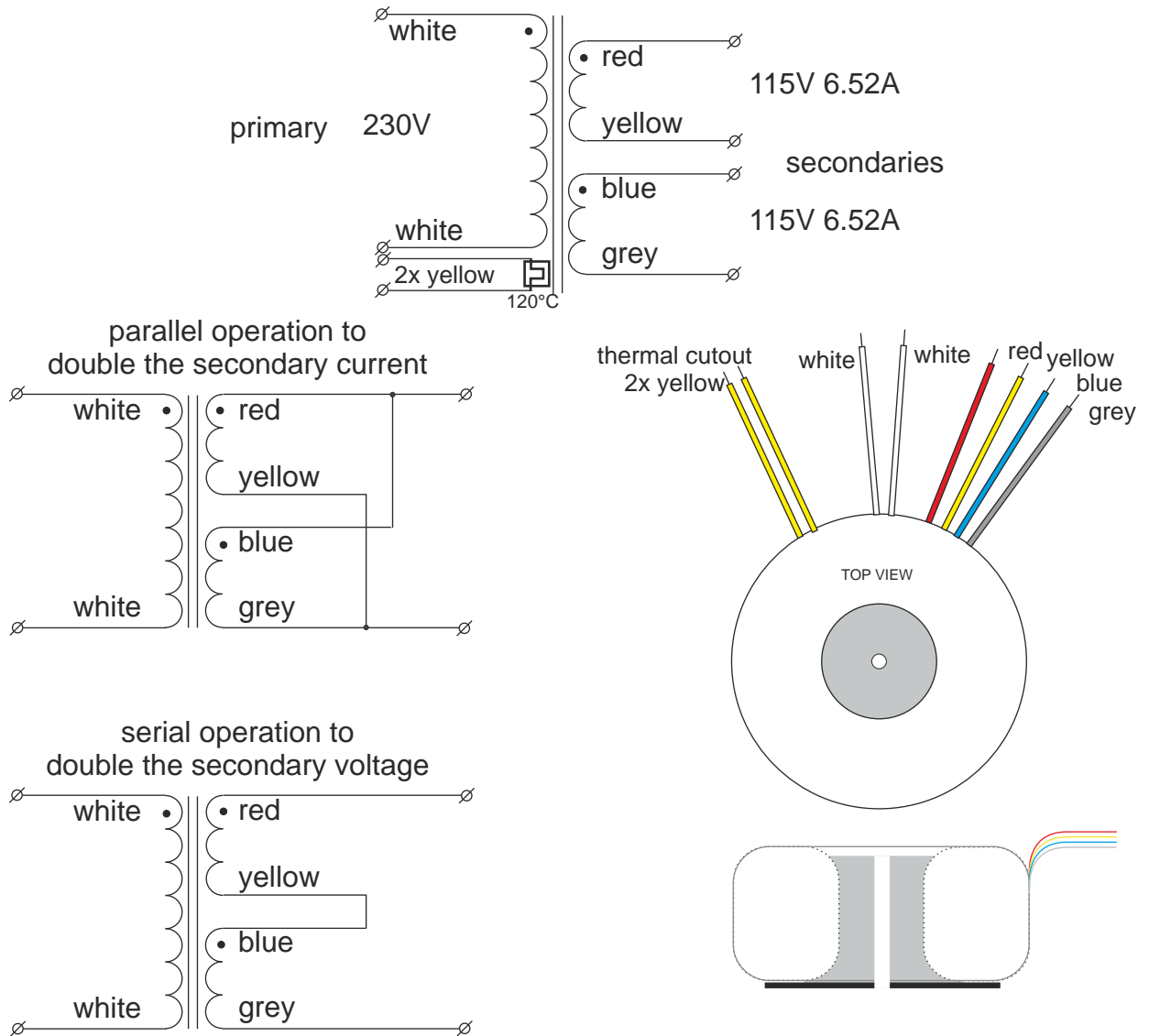





Diameter 200mm
 Height 100mm
 Weight 11.5kg
 Height and weight are measured without mounting materials
 All leads flexible and approx 200mm long
 Builtin selfresetting thermal cutout 120°C

Center potted with 8mm mountinghole
 Rubber washer supplied.

According to EN61558. With CE and UL/CSA approvals
 UL filenumber E311200
 RoHS-compliant

Type number	primary	secondaries voltage	current
L8670PT	230V	2x 115V	6.52A

All voltages are under full ohmic load.
Regulation : 3%

	P/N AMP-1500115	  
	TYPE L8670PT	
	BATCH 00000	50/60Hz
	MADE IN CHINA	 
PRI. 230VAC WHITE - WHITE		
SEC. 2x 115VAC 6.52A RED-YELLOW / BLUE-GREY		

	Industrieweg 14 NL-7161BX NEEDE The Netherlands P O - B o x 2 7 NL-7160AA NEEDE The Netherlands Tel.+31 (0)545 283456 Fax+31 (0)545 283457 info@amplimo.nl http://www.amplimo.nl	HB © Copyright Amplimo BV	Feb-2012 	L8670PT P/N: AMP-1500115 toroidal transformer 1500VA
---	---	--	----------------------------------	--