

### Toroidal transformer type 87015

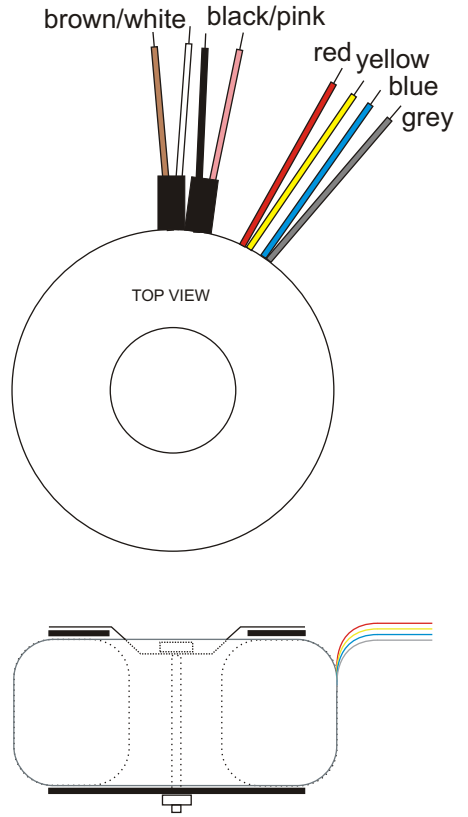
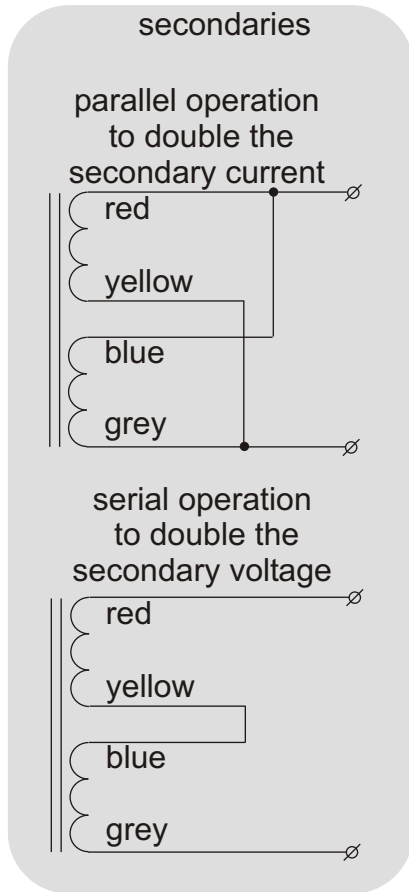
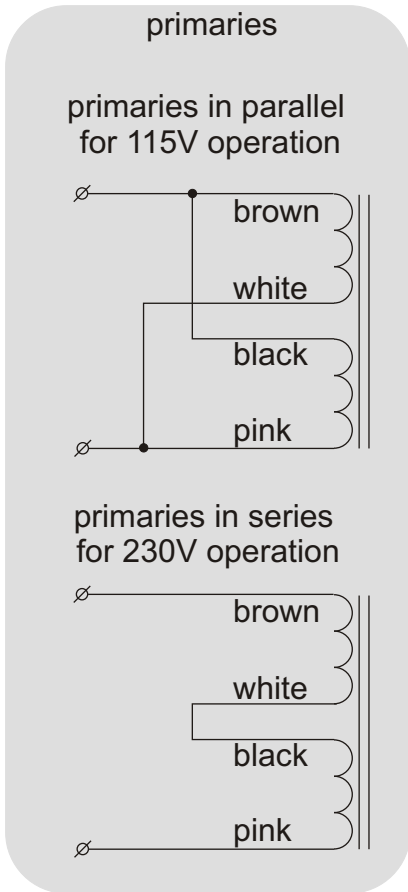
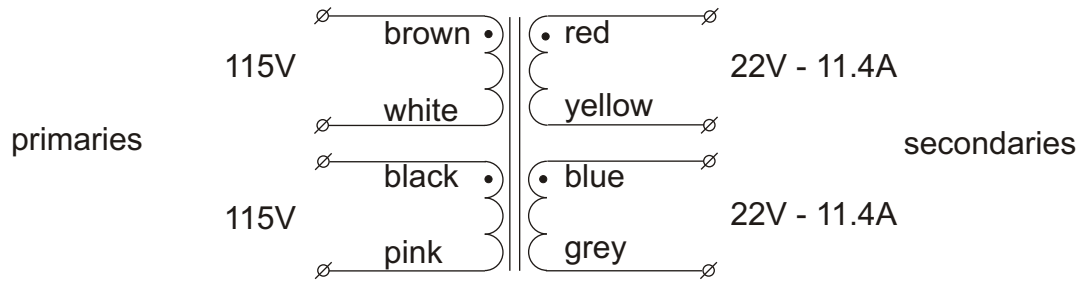

Diameter 135mm  
 Height 63mm  
 Weight 4.2kg  
 Height and weight are measured without mounting materials  
 All leads are solid and approx 200mm long

Supplied mounting materials:  
 1 metal washer Ø110mm  
 2 neoprene washers Ø110mm  
 1 bolt M8x70mm with nut

With KEMA KEUR, ENEC, CE and UL/CSA approvals  
 KEMA certificate 96 2307, UL filenumber E320377.

Time lag fuses to be used.  
 For 230V use: primary: 2.5A, 5x20mm, IEC127, high I<sup>2</sup>t value in series with two NTC-resistors type NTC5  
 secondary: none  
 For 115V use: primary: 5A, 5x20mm, IEC127, high I<sup>2</sup>t value in series with 2 NTC-resistors type NTC5  
 secondary: none

Type number	primary	secondaries voltage	current
87015	2x115V	2x 22V	11.4A

All voltages are under full ohmic load.  
 Regulation : 4.5%

500VA	115V / 230V	50Hz / 60Hz	
	KEMA KEUR	RoHS	
UL US	CCA	CB	CE

	Industrieweg 14 NL-7161BX NEEDE The Netherlands  P O - B o x 27 NL-7160AA NEEDE The Netherlands Tel. +31 (0)545 283456 Fax +31 (0)545 283457  info@amplimo.nl http://www.amplimo.nl	HB	Oct 2010	<h2>87015</h2> <p>toroidal transformer                  500VA                  for 115V or 230V operation</p>
	© Copyright Amplimo BV			