

## Toroidal transformer type 37015

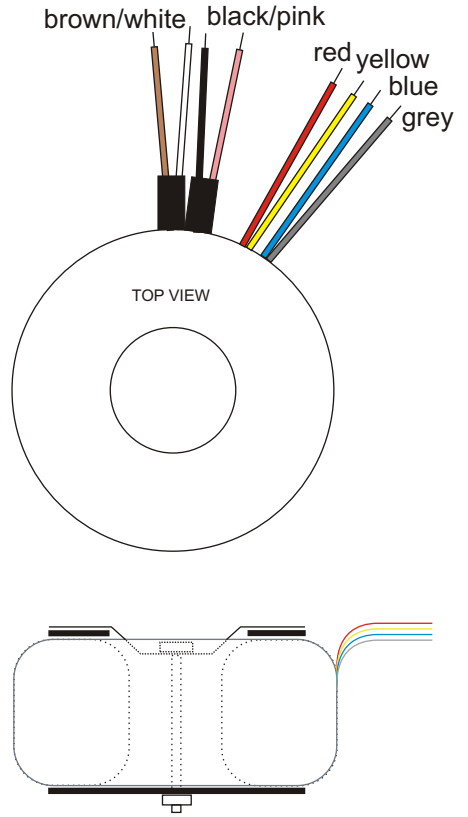
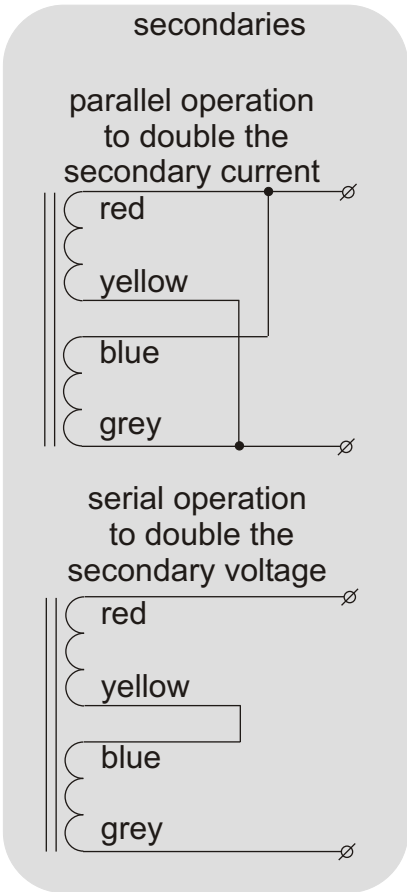
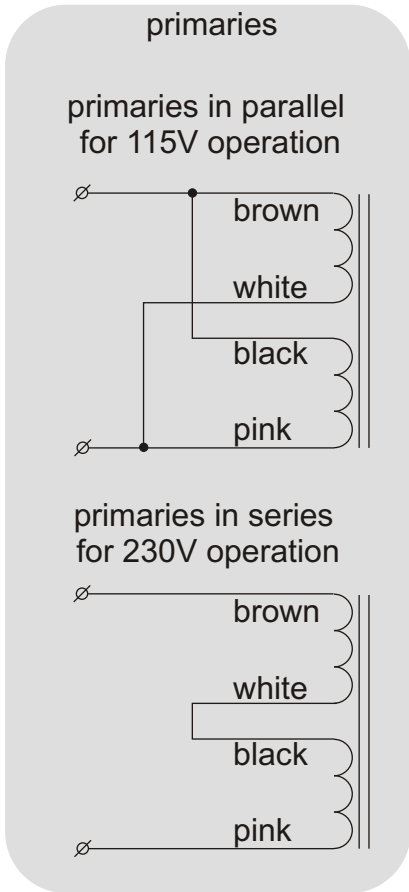
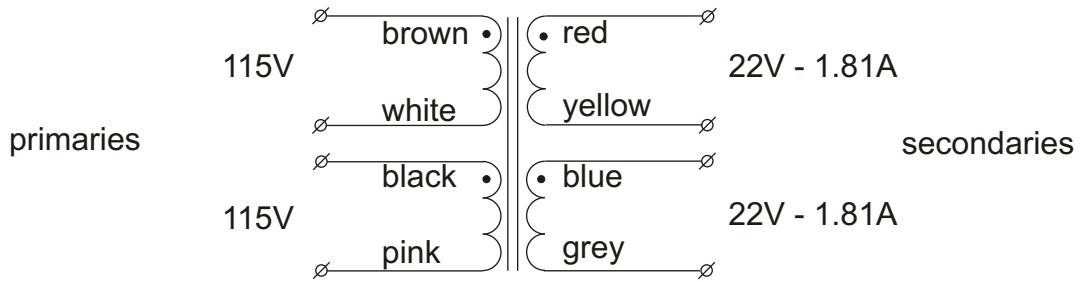

Diameter 91mm  
 Height 35mm  
 Weight 0.9kg  
 Height and weight are measured without mounting materials  
 All leads are solid and approx 200mm long

Supplied mounting materials:  
 1 metal washer Ø70mm  
 2 neoprene washers Ø70mm  
 1 bolt M5x40mm with nut

With KEMA KEUR, ENEC, CE and UL/CSA approvals  
 KEMA certificate 96 2307, UL filenumber E320377.

Time lag fuses to be used.  
 For 230V use: primary: 0.4A, 5x20mm, IEC127, high I<sup>2</sup>t value  
 secondary: none  
 For 115V use: primary: 0.8A, 5x20mm, IEC127, high I<sup>2</sup>t value  
 secondary: none

Type number	primary	secondaries voltage	current
37015	2x115V	2x 22V	1.81A

All voltages are under full ohmic load.  
 Regulation : 10%

80VA	115V / 230V	50Hz / 60Hz	
	KEMA KEUR		
	CCA	CB	CE

	Industrieweg 14 NL-7161BX NEEDE The Netherlands  P O - B o x 27 NL-7160AA NEEDE The Netherlands Tel.+31 (0)545 283456 Fax+31 (0)545 283457  info@amplimo.nl http://www.amplimo.nl	HB	Oct 2010	<h1 style="margin: 0;">37015</h1> <p style="margin: 0;">toroidal transformer 80VA for 115V or 230V operation</p>
	© Copyright Amplimo BV			