

Toroidal transformer type 27012

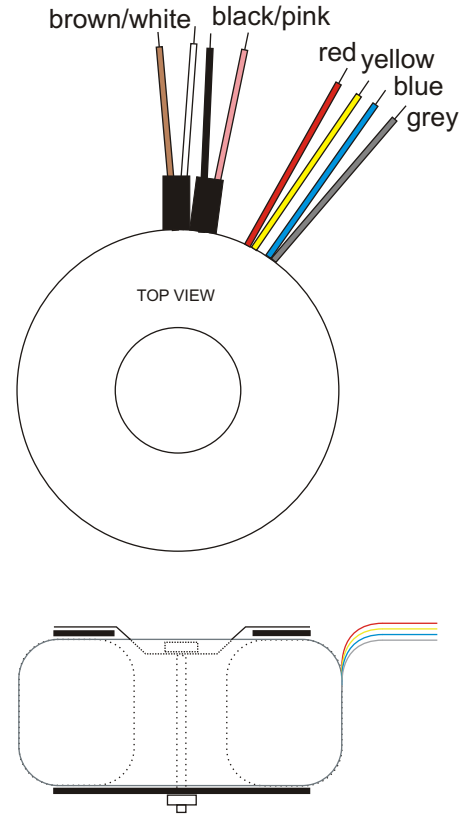
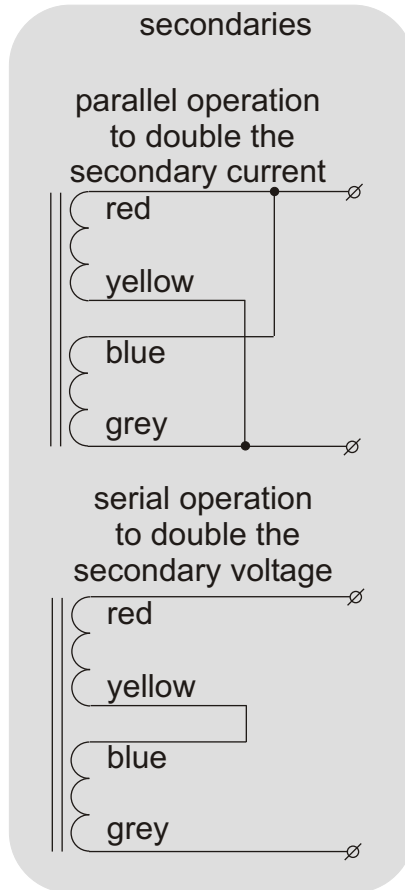
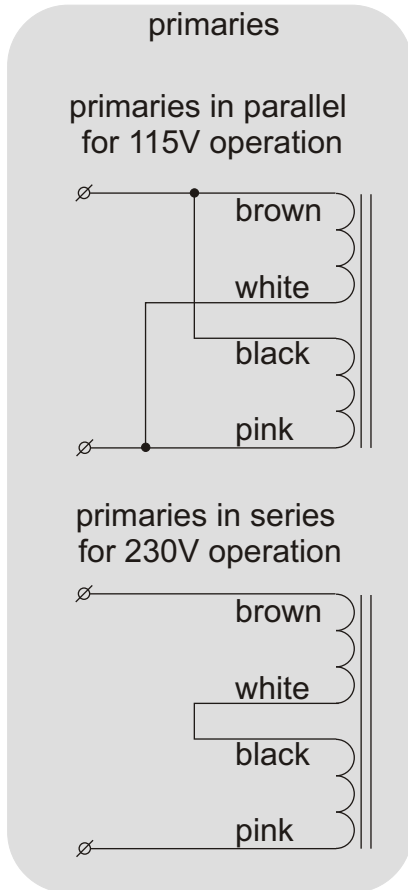
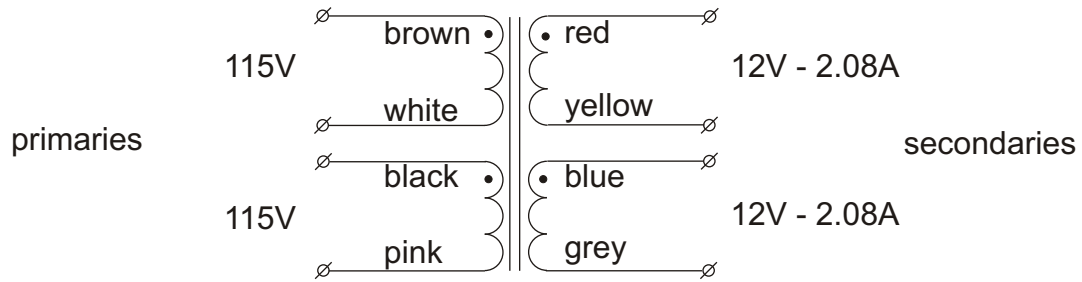

Diameter 80mm
 Height 39mm
 Weight 0.74kg
 Height and weight are measured without mounting materials
 All leads are solid and approx 200mm long

Supplied mounting materials:
 1 metal washer Ø70mm
 2 neoprene washers Ø70mm
 1 bolt M5x50mm with nut

With KEMA KEUR, ENEC, CE and UL/CSA approvals
 KEMA certificate 96 2307, UL filenumber E320377.

Time lag fuses to be used.
 For 230V use: primary: 0.25A, 5x20mm, IEC127, high I²t value
 secondary: none
 For 115V use: primary: 0.5A, 5x20mm, IEC127, high I²t value
 secondary: none

Type number	primary	secondaries voltage	current
27012	2x115V	2x12V	2.08A

All voltages are under full ohmic load.
Regulation : 12%

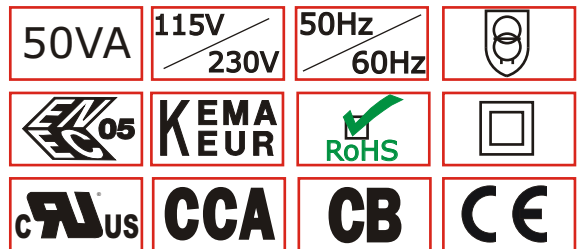

	Industrieweg 14 NL-7161BX NEEDE The Netherlands P O - B o x 27 NL-7160AA NEEDE The Netherlands Tel.+31 (0)545 283456 Fax+31 (0)545 283457	HB	Oct 2010	<h1 style="margin: 0;">27012</h1> <p style="margin: 0;">toroidal transformer 50VA for 115V or 230V operation</p>
	info@amplimo.nl http://www.amplimo.nl			
	©	Copyright Amplimo BV		