

Toroidal transformer type 17010

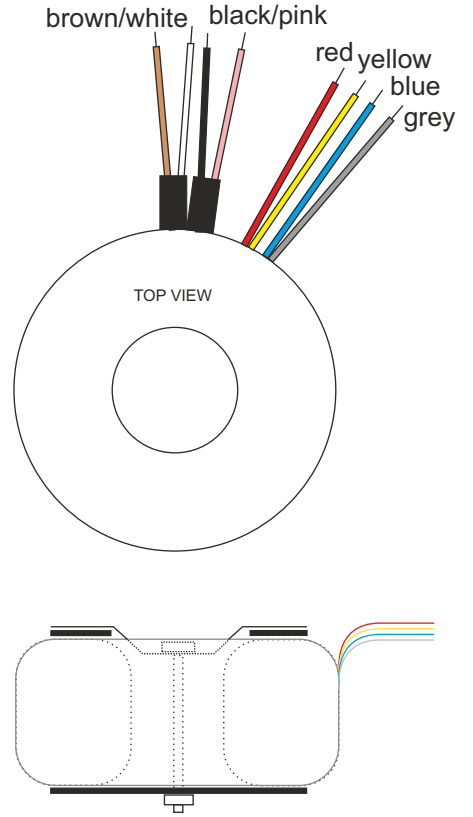
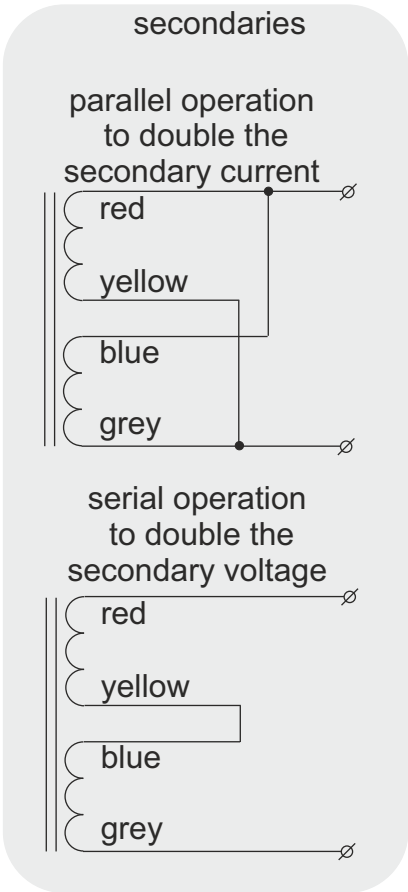
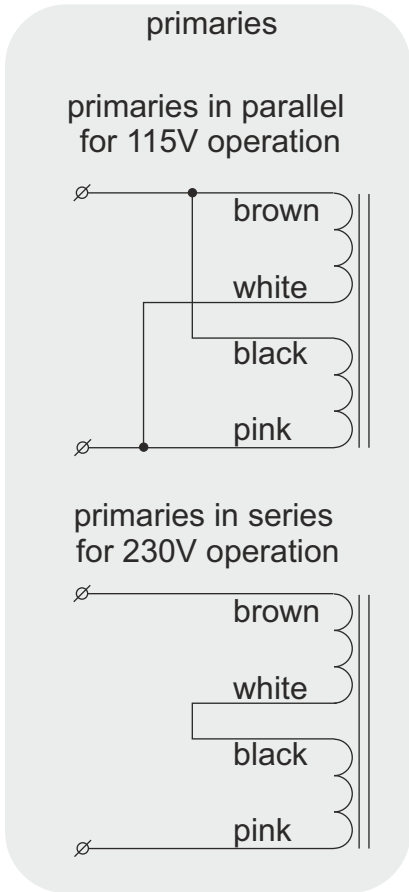
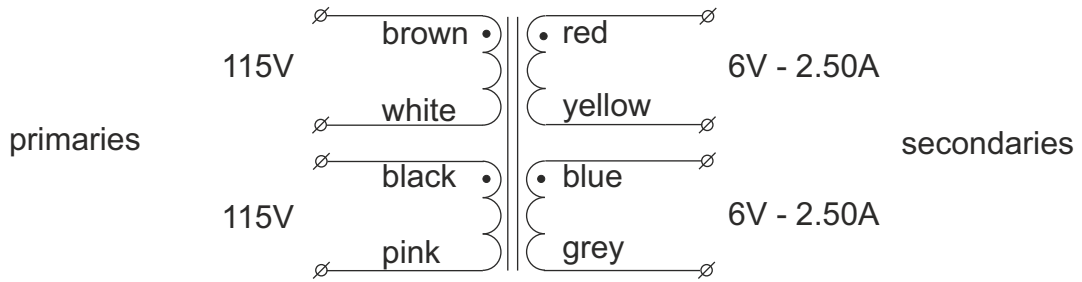

Diameter 70mm
 Height 32mm
 Weight 0.44kg
 Height and weight are measured without mounting materials
 All leads are solid and approx 200mm long

Supplied mounting materials:
 1 metal washer Ø50mm
 2 neoprene washers Ø50mm
 1 bolt M5x40mm with nut

KEMA KEUR, ENEC approvals, certificate 2159403.01
 UL/CSA approvals, UL filenumber E320377.
 CE, RoHS-compliant

Time lag fuses to be used.
 For 230V use: primary: 0.16A, 5x20mm, IEC127, high I²t value
 secondary: none
 For 115V use: primary: 0.315A, 5x20mm, IEC127, high I²t value
 secondary: none

Type number	primary	secondaries voltage	current
17010	2x115V	2x 6V	2.50A

All voltages are under full ohmic load.
 Regulation : 17%

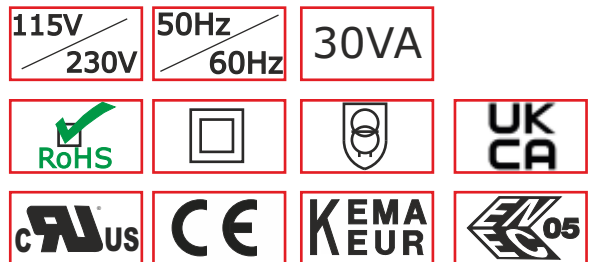

	Industrieweg 14 NL-7161BX NEEDE The Netherlands P O - B o x 2 7 NL-7160AA NEEDE The Netherlands Tel.+31 (0)545 28 3456 info@amplimo.nl https://www.amplimo.nl	HB HB	Oct 2010 Apr 2023	<h1 style="margin: 0;">17010</h1> <p style="margin: 0;">toroidal transformer range 30VA for 115V or 230V operation</p>
	© Copyright Amplimo BV			