

# Toroidal transformer type 07014

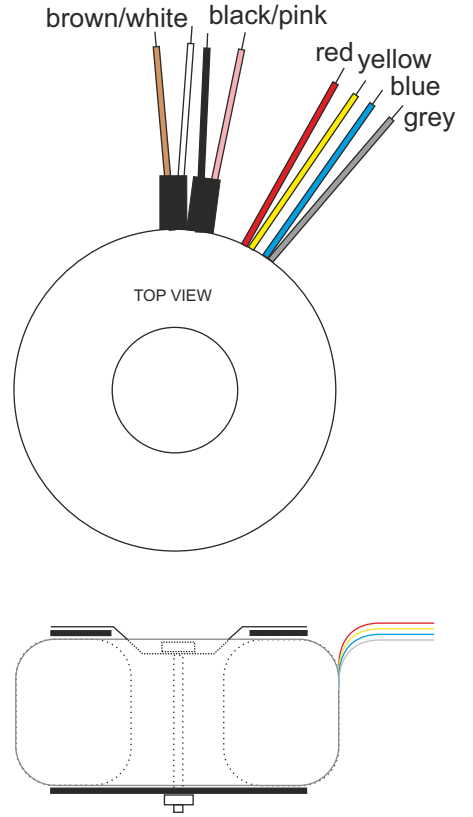
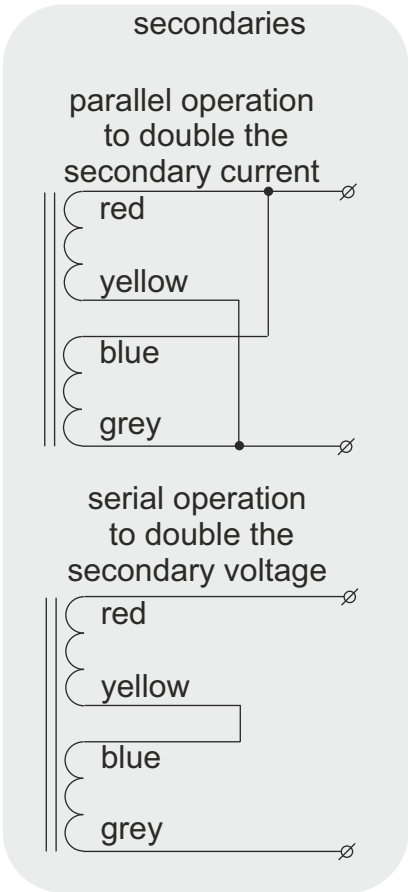
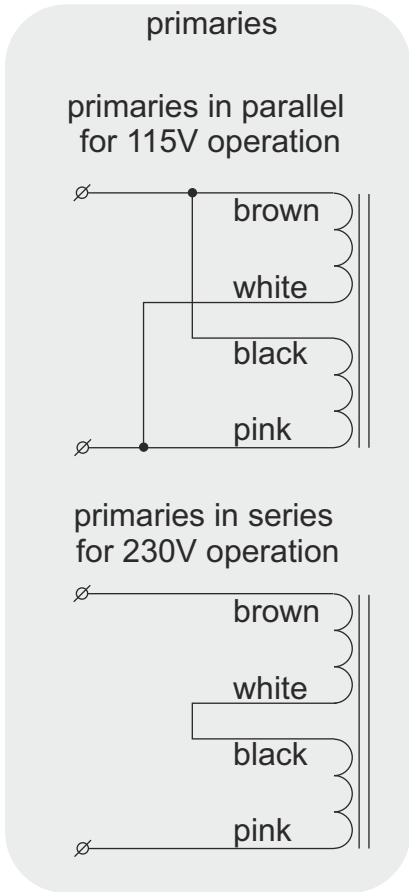
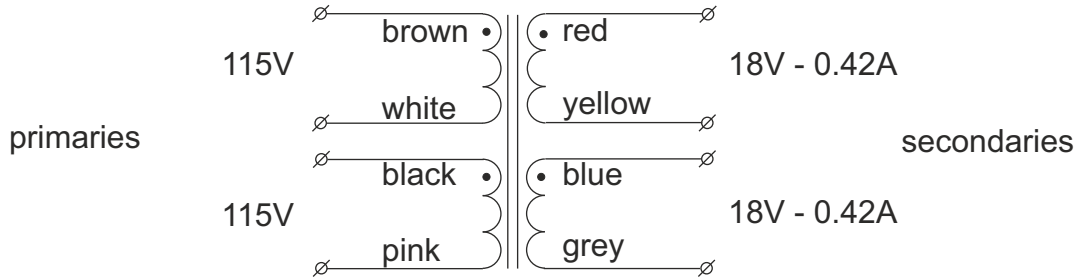

Diameter 60mm  
 Height 28mm  
 Weight 0.31kg  
 Height and weight are measured without mounting materials  
 All leads are solid and approx 200mm long

Supplied mounting materials:  
 1 metal washer Ø50mm  
 2 neoprene washers Ø50mm  
 1 bolt M5x40mm with nut

KEMA KEUR, ENEC approvals, certificate 2159403.01  
 UL/CSA approvals, UL filenumber E320377.  
 CE, RoHS-compliant

Time lag fuses to be used.  
 For 230V use: primary: 0.08A, 5x20mm, IEC127, high I<sup>2</sup>t value  
 secondary: none  
 For 115V use: primary: 0.16A, 5x20mm, IEC127, high I<sup>2</sup>t value  
 secondary: none

Type number	primary	secondaries voltage	current
07014	2x115V	2x 18V	0.42A

All voltages are under full ohmic load.  
 Regulation : 19%

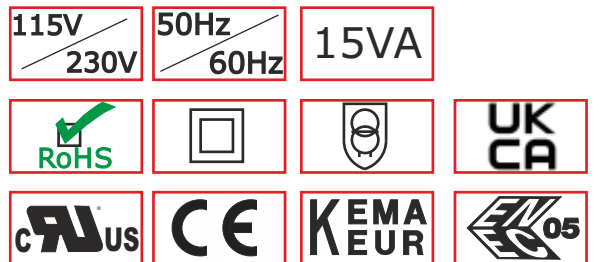

	Industrieweg 14 NL-7161BX NEEDE The Netherlands  P O - B o x 2 7 NL-7160AA NEEDE The Netherlands Tel.+31 (0)545 28 3456  info@amplimo.nl https://www.amplimo.nl	HB HB	Oct 2010 Apr 2023	<h2>07014</h2> <p>toroidal transformer                  range 15VA                  for 115V or 230V operation</p>
	© Copyright Amplimo BV			